

www.alunextmaterial.com

Alu Next Material Co., Ltd.

PRODUCT CATALOGUE



ABOUT US

Alu Next Material Co., Ltd.
(อลู เน็กซ์ แมททีเรียล จำกัด)

Alu Next Material คือผู้เชี่ยวชาญด้าน Aluminium และ Stainless Steel Materials ด้วยประสบการณ์ในธุรกิจวัสดุก่อสร้าง และงานรับเหมาก่อสร้างมากกว่า 30 ปี เราเข้าใจความต้องการของงานก่อสร้างอย่างลึกซึ้ง และมุ่งมั่นพัฒนาวัสดุที่ตอบโจทย์ทั้งด้านฟังก์ชัน ความสวยงาม และ ความทนทานในระยะยาว

ด้วยทีมงานที่ทุ่มเททั้งด้าน Sales, Production และ Technical เราได้ทำงานร่วมกับเจ้าของโครงการ สถาปนิกผู้ออกแบบ และ ผู้รับเหมา พร้อมนำเสนอโซลูชัน สำหรับอุตสาหกรรมก่อสร้าง ให้กับลูกค้า ทั่วประเทศอย่างต่อเนื่อง

Line ID : @alunext
063-4255593 , 095-4165914
www.alunextmaterial.com



Alu Next Material มีความเชี่ยวชาญเป็นพิเศษ ในกลุ่มวัสดุสำหรับ งานจบพื้น และ ผนัง (Floor & Wall Finishing Materials) ไม่ว่าจะเป็น

- คิ้วกระเบื้อง
- จมูกบันได
- ตัวปิดรอยต่อพื้นและผนัง
- คิ้วรอยต่อ
- บัวพื้น

โดยมีให้เลือกครบทุกประเภทวัสดุ เพื่อตอบโจทย์ ทุกรายละเอียดของงานออกแบบ และ การใช้งานจริง

เราให้ความสำคัญกับทุกขั้นตอน ตั้งแต่การคัดเลือก วัสดุการออกแบบ ไปจนถึงการติดตั้ง โดยมีทีมช่าง ผู้เชี่ยวชาญที่ผ่านการฝึกอบรมโดยตรงจากบริษัทผู้ผลิต และ มีประสบการณ์ด้านการติดตั้งจริง เพื่อให้มั่นใจว่า งานทุกชิ้นจะได้มาตรฐานสูงสุด ทั้งด้านคุณภาพ ความสวยงาม และ ความปลอดภัย

Alu Next Material
เพราะรายละเอียดเล็กๆ
คือคุณภาพของงานทั้งระบบ



L SHAPE TILE TRIM



Model Number	Height(mm)	Width(mm)
AN-AL-L	6.5	2
AN-AL-L	8	2
AN-AL-L	10	2
AN-AL-L	11	2
AN-AL-L	12.5	2
AN-AL-L	15	2
AN-AL-L	16	2
AN-AL-L	18	2
AN-AL-L	20	2
AN-AL-L	25	2



Model Number	Height(mm)	Width(mm)
AN-AL-LC	7.1	3
AN-AL-LC	11.6	3

ROUND SHAPE TILE TRIM

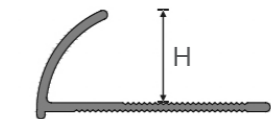

Model Number	Height(mm)
AN-AL-R	6
AN-AL-R	8
AN-AL-R	10
AN-AL-R	12

SQUARE SHAPE TILE TRIM

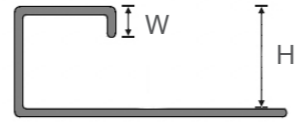

Model Number	Height(mm)	Width(mm)
AN-AL-S	8	3
AN-AL-S	10	3
AN-AL-S	12	3

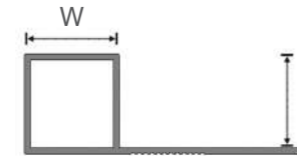

Model Number	Height(mm)	Width(mm)
AN-AL-S	8	8
AN-AL-S	10	10
AN-AL-S	12	12

MULTIPLE CHOICES



T SHAPE PROFILE

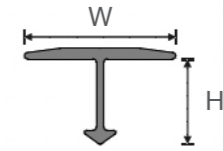

Model Number	Height(mm)	Width(mm)
AN-AL-T	8	10
AN-AL-T	8	14
AN-AL-T	8	20
AN-AL-T	8	24

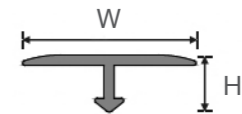

Model Number	Height(mm)	Width(mm)
AN-AL-TS	4	10
AN-AL-TS	4	15
AN-AL-TS	4	20

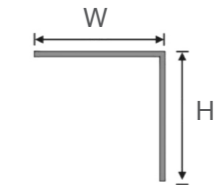

Model Number	Height(mm)	Width(mm)
AN-AL-AG	20	20
AN-AL-AG	25	25

U SHAPE PROFILE

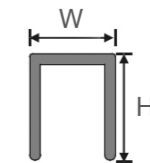

Model Number	Height(mm)	Width(mm)
AN-AL-B	10	5
AN-AL-B	10	10
AN-AL-B	10	15
AN-AL-B	10	25
AN-AL-B	10	40

STAIR NOSING

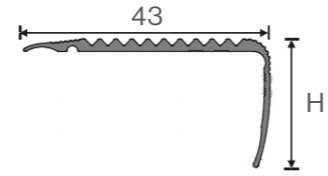

Model Number	Height(mm)
AN-AL-SN1	22.3

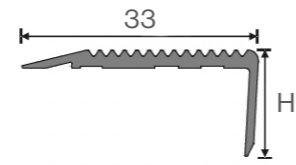

Model Number	Height(mm)
AN-AL-SN2	14.9

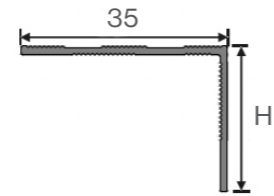
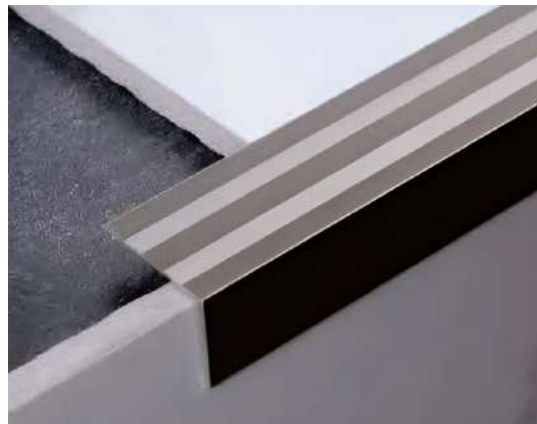

Model Number	Height(mm)
AN-AL-SN3	24.5

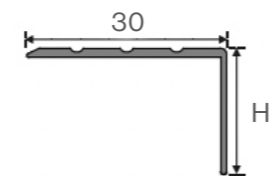

Model Number	Height(mm)
AN-AL-SN4	19

STAIR NOSING

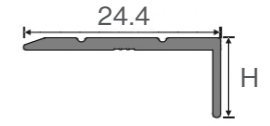
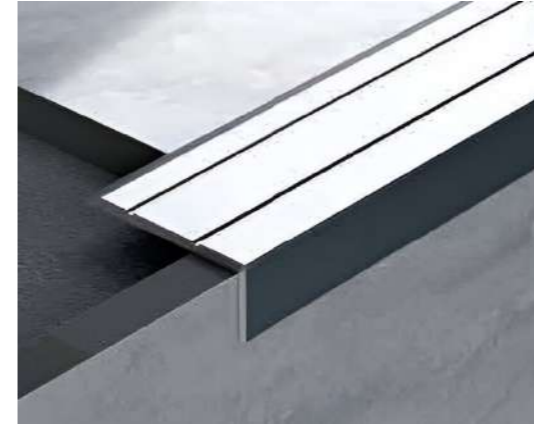

Model Number	Height(mm)
AN-AL-SN5	10

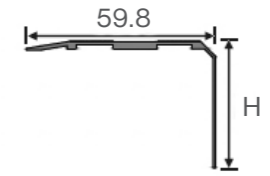

Model Number	Height(mm)
AN-AL-SN6	39.8

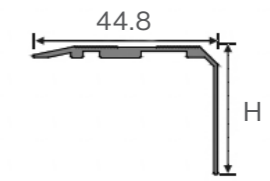

Model Number	Height(mm)
AN-AL-SN7	31.9

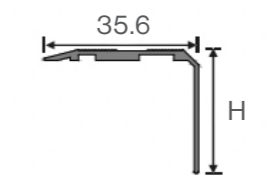
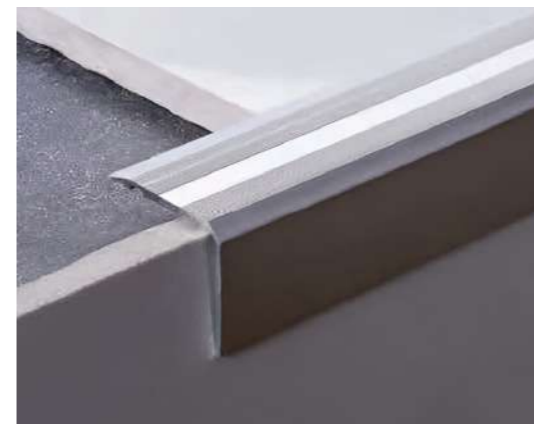

Model Number	Height(mm)
AN-AL-SN8	29.8

STAIR NOSING

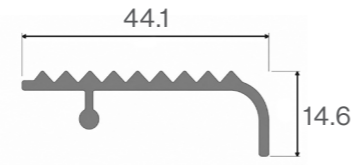

Model Number	Height(mm)
AN-AL-SN9	14.6

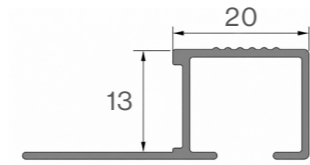

Model Number	Height(mm)
AN-AL-SN10	13

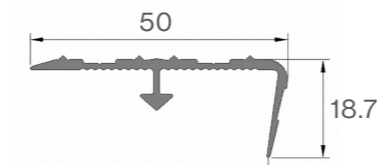

Model Number	Height(mm)
AN-AL-SN11	18.7

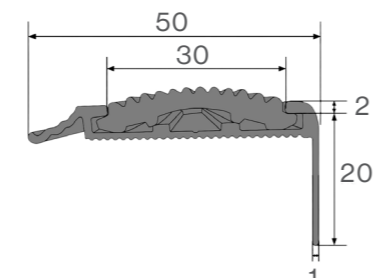
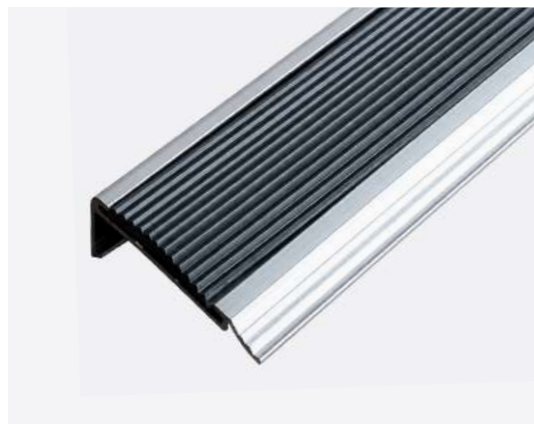

Model Number	Height(mm)
AN-AL-SNS	20

SKIRTING BOARD



Left End Cap



Inside Corner



Outside Corner



Right End Cap



Aluminum Base

COLOR OPTION

Other colors available for customization



Black



Dark Grey

Model Number	Height(mm)	Width(mm)	Applicable LED Strip Width(mm)	Color
AN-AL-SKL1	60	8.6	3-5	Black, Dark Grey
AN-AL-SKL1	80	10	3-5	

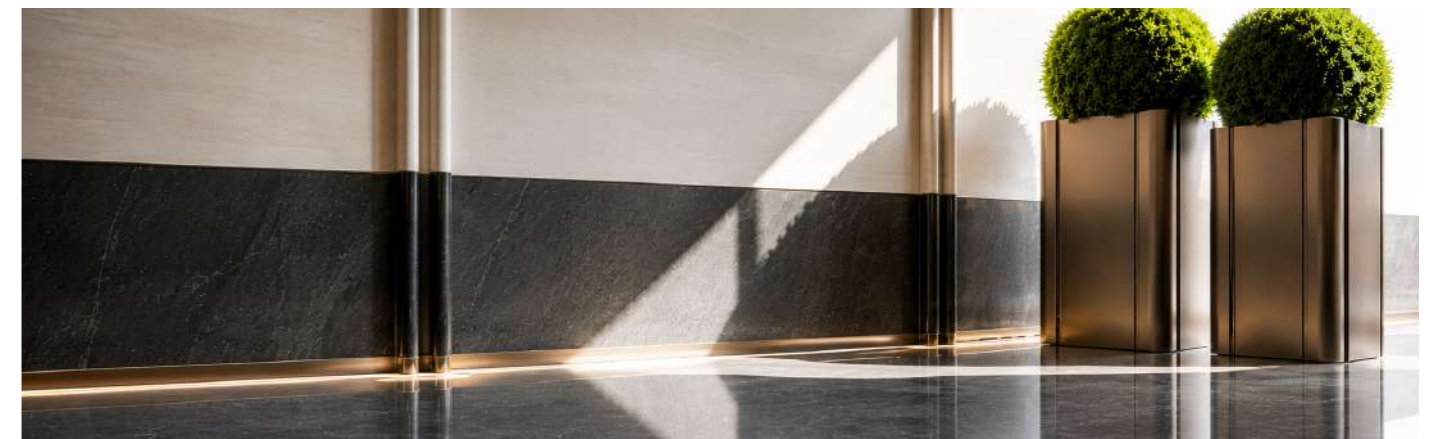

SKIRTING BOARD



VDO Installation



Left/Right End Cap



Outside Corner



Connector



Inside Corner

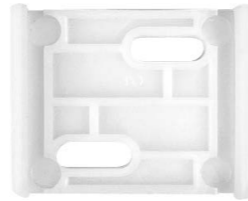

PVC Clips

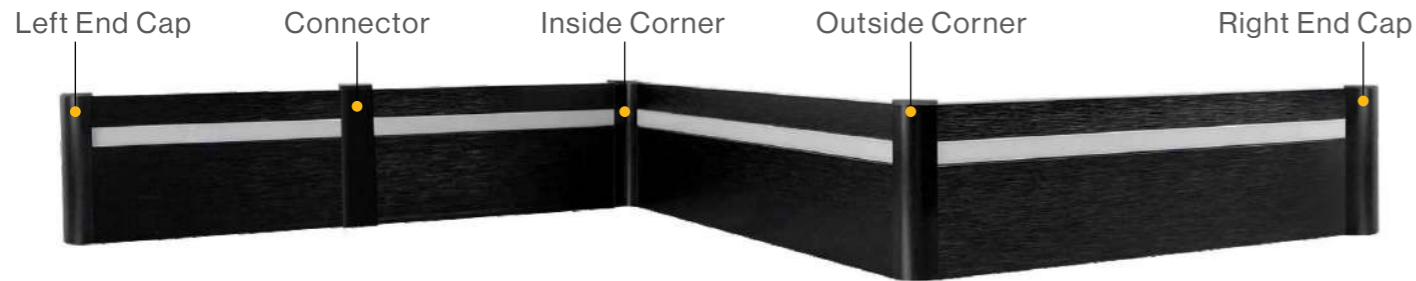

COLOR OPTION

Other colors available for customization



Black Brushed



Rose Gold Brushed



Iron Grey Brushed



White

Model Number	Height(mm)	Width(mm)	Applicable LED Strip Width(mm)	Color
AN-AL-SKL2	80	10	8	Black Brushed, Rose Gold Brushed, Iron Grey Brushed
AN-AL-SKL2	100	10	8	Black Brushed, White
AN-AL-SKL2	120	10	8	

SKIRTING BOARD

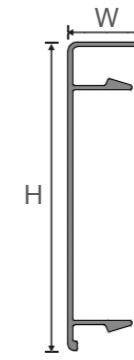
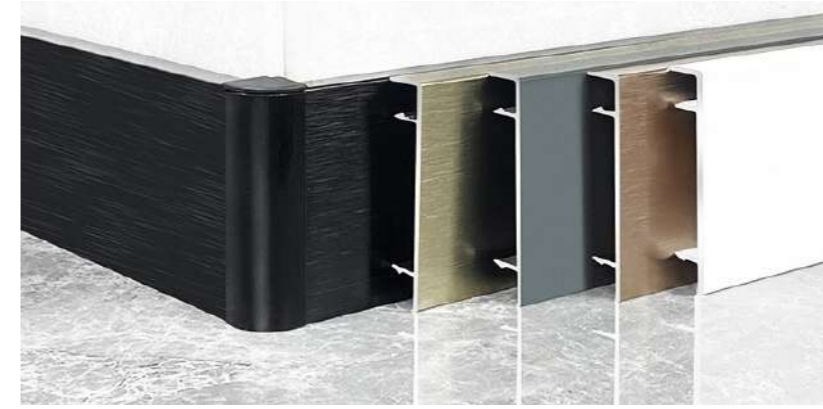

Internal Corner



External Corner



Connector



End Cap



Base

Model Number	Height(mm)	Width(mm)
AN-AL-SK1	40	12
AN-AL-SK1	50	12
AN-AL-SK1	60	12
AN-AL-SK1	80	12
AN-AL-SK1	100	12

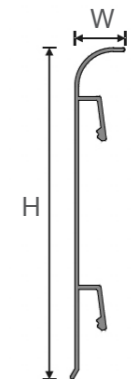

VDO Installation



Internal Corner



External Corner



Connector



Left End Cap

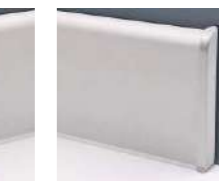

Right End Cap



Locker

Model Number	Height(mm)	Width(mm)
AN-AL-SK3	80	10.4
AN-AL-SK3	100	10.4

SKIRTING BOARD

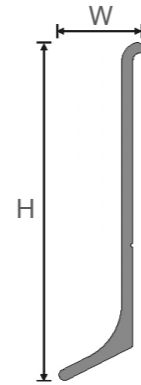

Model Number	Height(mm)	Width(mm)
AN-AL-SK2	40	10.5
AN-AL-SK2	50	10.5
AN-AL-SK2	60	10.5
AN-AL-SK2	80	10.5
AN-AL-SK2	100	10.5
AN-AL-SK2	120	10.5
AN-AL-SK2	150	10.5



SKIRTING BOARD



COLOR OPTION

Other colors available for customization



Model Number	Height(mm)	Width(mm)	Color
AN-AL-SK4	40	8.2	Black, Gummetal Grey, Meridian Grey
AN-AL-SK4	60	8.2	White, Pale Latte, Coco Cream, Black Walnut
AN-AL-SK4	80	8.2	American Oak, Teak Wood, White Oak
AN-AL-SK4	100	8.2	Yellow Oak, Manchurian Ash, Silver Pear

SKIRTING BOARD



COLOR OPTION

Other colors available for customization



Model Number	Height(mm)	Width(mm)	Color
AN-AL-SK5	30	8.2	Apricot, Coco Cream, Ru Celadon Light Grey, Milk Grey, Pale Latte Black, Gunmetal Grey, Iron Grey
AN-AL-SK5	40	8.2	
AN-AL-SK5	50	8.2	
AN-AL-SK5	60	8.2	
AN-AL-SK5	100	8.2	

SKIRTING BOARD

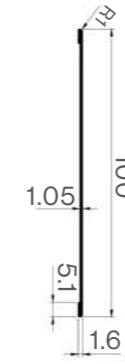

COLOR OPTION

Other colors available for customization



Model Number	Height(mm)	Width(mm)	Color
AN-AL-SK7	100	1.6	Silver, Sahara Black, Black

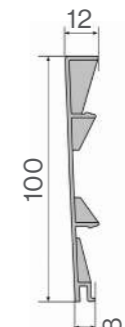

Model Number	Height(mm)	Width(mm)
AN-AL-SK8	100	12

SKIRTING BOARD (SHADOW GAP)



COLOR OPTION
Other colors available for customization

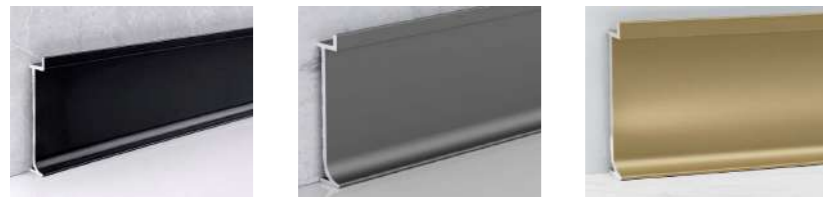

Model Number	Height(mm)	Width(mm)	Color
AN-AL-SG	20	9	Black, Iron Grey, Gold
AN-AL-SG	30	9	
AN-AL-SG	50	9	
AN-AL-SG	80	9	Black, Iron Grey

SKIRTING BOARD (SHADOW GAP)



COLOR OPTION
Other colors available for customization

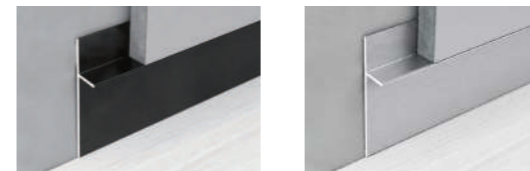

Model Number	Height(mm)	Width(mm)	Color
AN-AL-SG1	56	12	Black, Silver

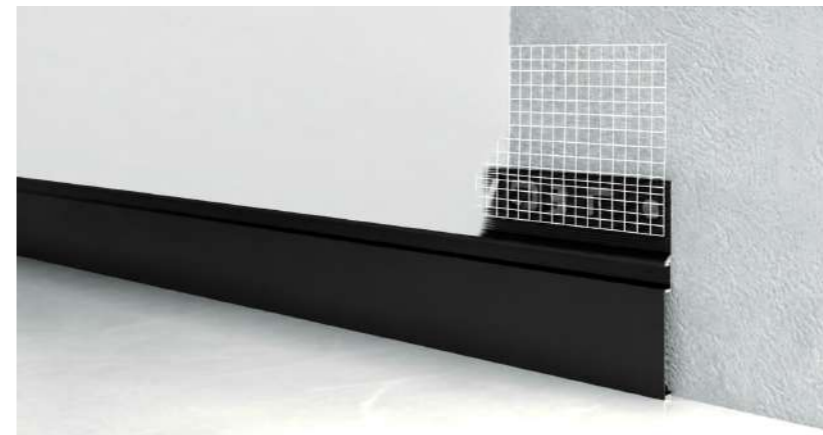

COLOR OPTION
Other colors available for customization



Model Number	Height(mm)	Width(mm)	Color
AN-AL-SG2	50	3	Black, Silver

STAINLESS STEEL SKIRTING BOARD

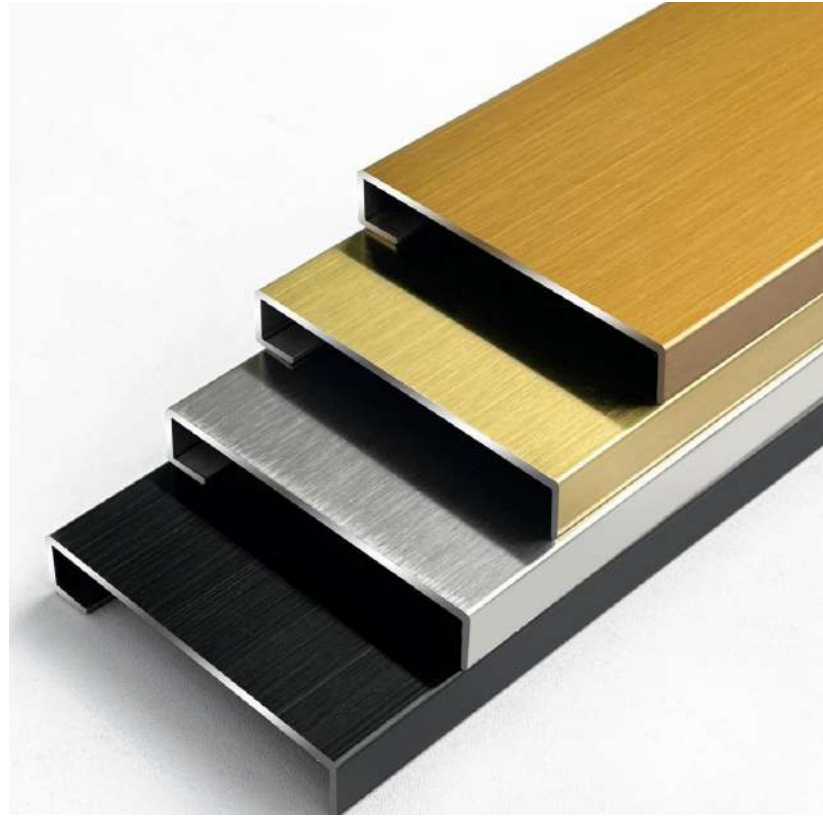

INSTALLATION DIAGRAM

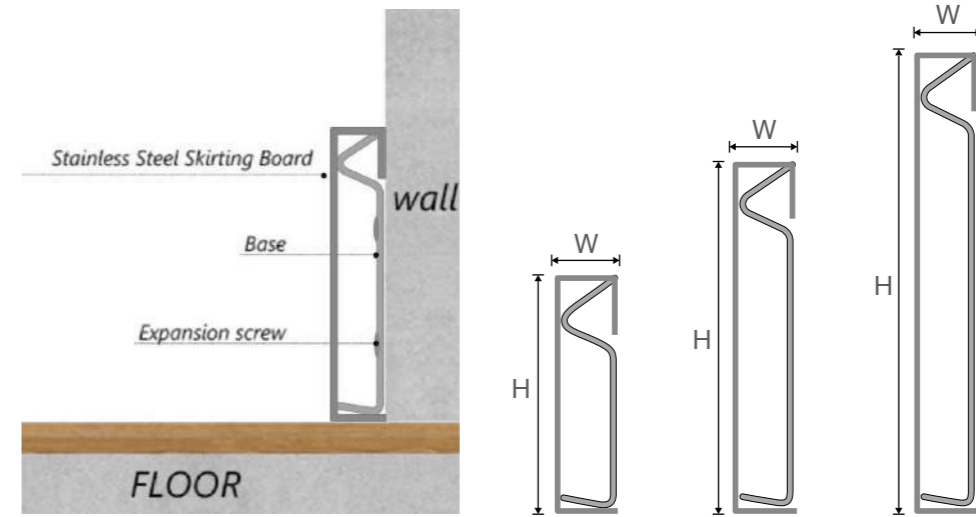

Inside Corner



Outside Corner



Connector



Left End Cap



Right End Cap



FRONT INSTALLATION ILLUSTRATION

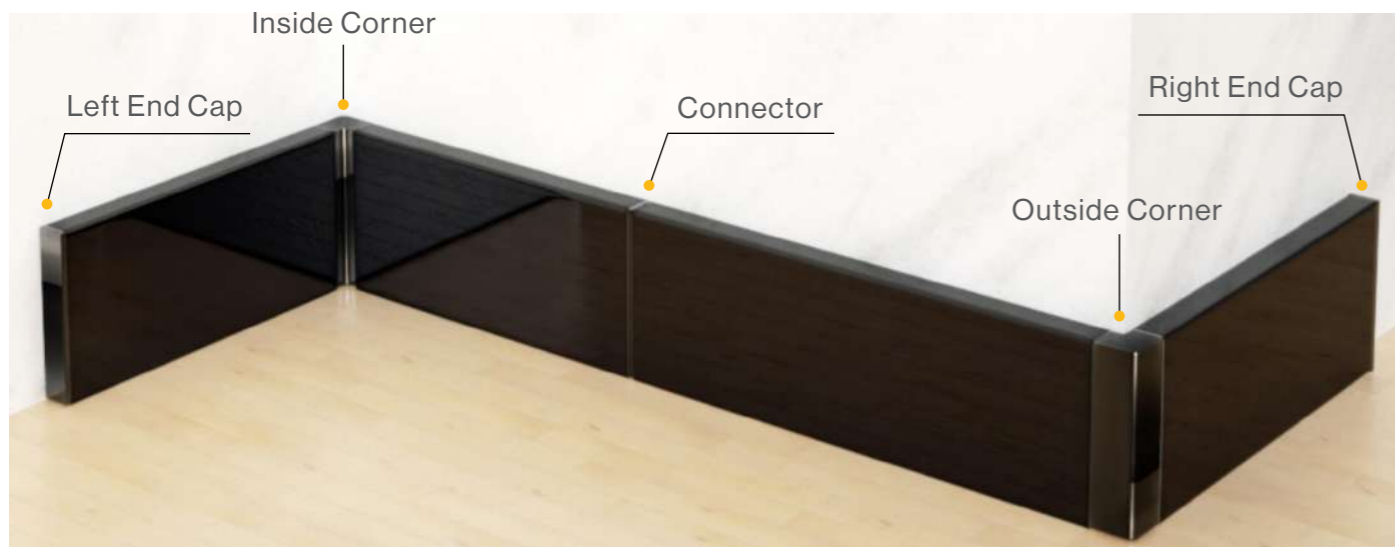

COLOR OPTION

Other colors available for customization



Black Brushed

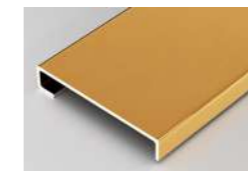

Rose Gold Brushed

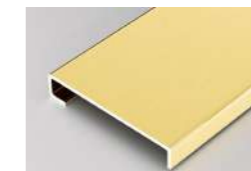

Gold Brushed



Silver Brushed



Bronze Brushed

Model Number	Height(mm)	Width(mm)	Color
AN-SS-SK	40	10	Black Brushed, Rose Gold Brushed Gold Brushed, Silver Brushed Bronze Brushed
AN-SS-SK	60	10	
AN-SS-SK	80	10	
AN-SS-SK	100	10	

STAINLESS STEEL TILE TRIM



Model Number	Height(mm)	Thickness(mm)
AN-SS-L	12/14	1

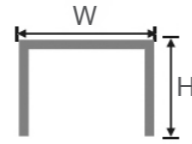

Model Number	Height(mm)	Width(mm)	Thickness(mm)
AN-SS-B	10	5/10/15 25/40	1

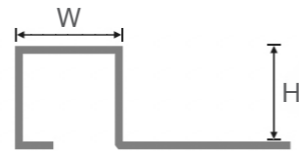

Model Number	Height(mm)	Width(mm)	Thickness(mm)
AN-SS-U1	12/14	12/14	1



Model Number	Height(mm)	Width(mm)	Thickness(mm)
AN-SS-U3	12/14	12/14	1

STAINLESS STEEL TILE TRIM



Model Number	Height(mm)	Thickness(mm)
AN-SS-R	12/14	1

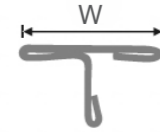

Model Number	Width(mm)	Thickness(mm)
AN-SS-ST	10/15/20/40	1

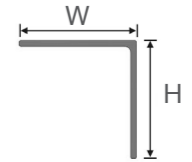

Model Number	Height(mm)	Width(mm)	Thickness(mm)
AN-SS-AG	10/15/25	10/15/25	1

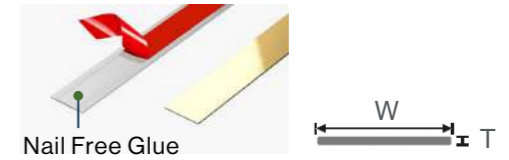
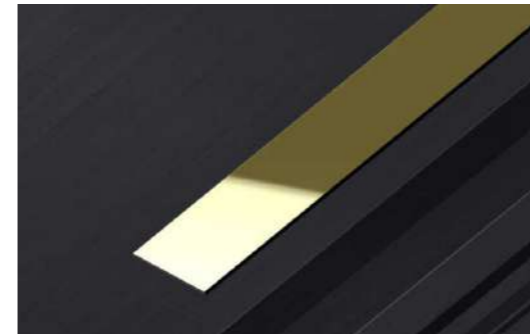

Model Number	Width(mm)	Thickness(mm)
AN-SS-SG	15/20/40	0.3/0.4/0.5

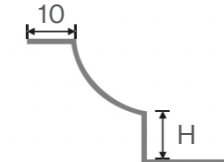

Model Number	Height(mm)	Thickness(mm)
AN-SS-C	10	1

STAINLESS STEEL STAIR NOSE

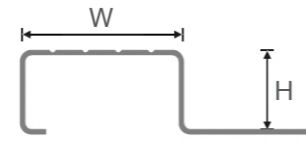
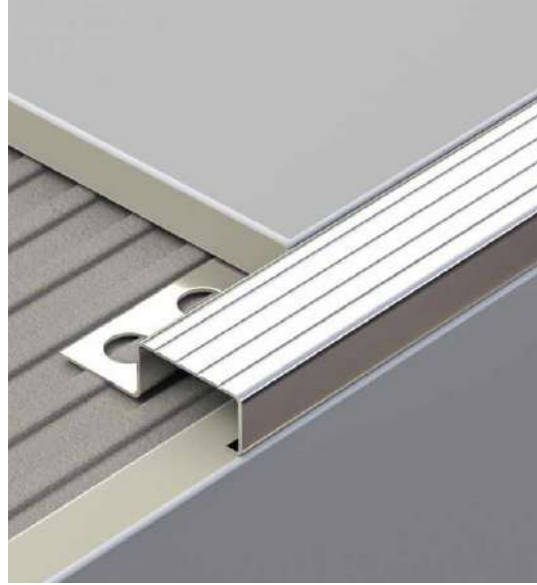

Model Number	Height(mm)	Width(mm)	Thickness(mm)
AN-SS-SN	12	40/45/50	1



Model Number	Height(mm)	Width(mm)	Thickness(mm)
AN-SS-SN2	22	40/45/50	1

CEILING PRODUCT LINE

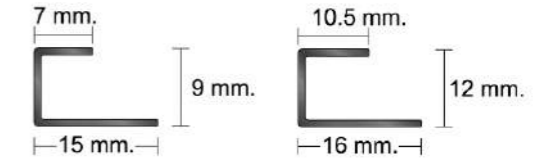

Model Number	Height(mm)	Width(mm)
AN-PVC-U	9	15
AN-PVC-U	12	16

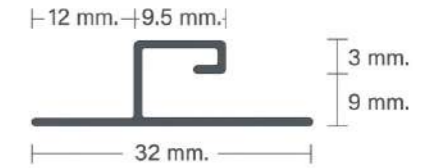

Model Number	Height(mm)	Width(mm)
AN-PVC-C	12	32

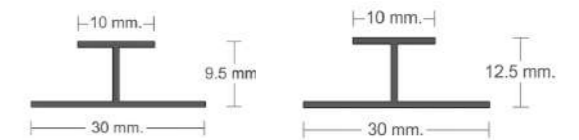

Model Number	Height(mm)	Width(mm)
AN-PVC-I	9.5	30
AN-PVC-I	12.5	30

FLOORING PRODUCT LINE



BLIND ROAD BRICK

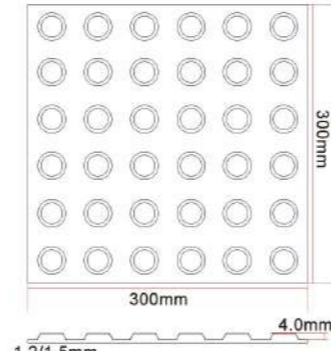
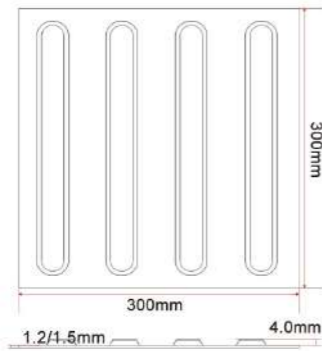
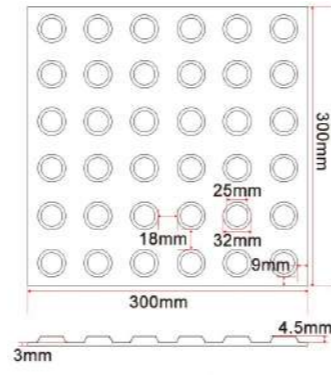
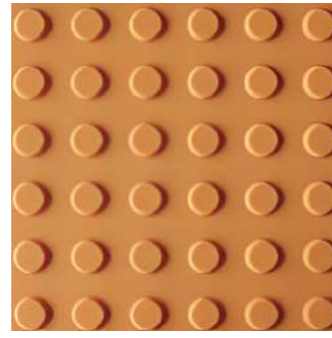
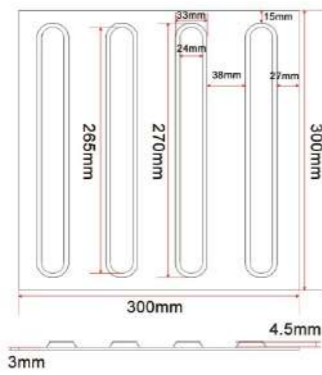

Model Number	Material
AN-BBS-01	TPU
AN-BBS-02	SS304
AN-BBS-03	SS316

Model Number	Material
AN-BBD-01	TPU
AN-BBD-02	SS304
AN-BBD-03	SS316

BLIND ROAD ARTICLE

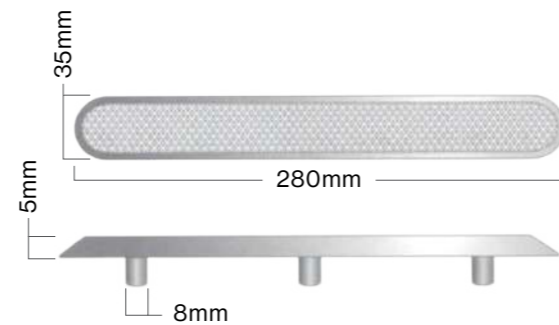
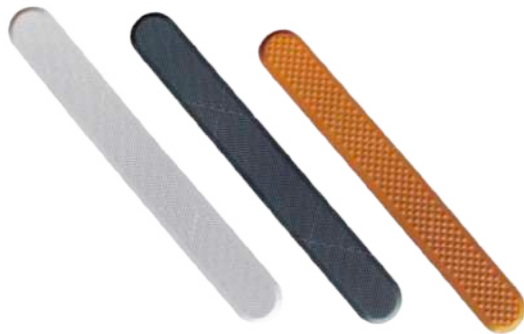

Model Number	Material
AN-PBS-01	TPU
AN-PBS-02	SS304
AN-PBS-03	SS316

FLOORING PRODUCT LINE



BLIND ROAD STUDS



Model Number	Material
AN-BRS-01	SS304
AN-BRS-02	SS316



Model Number	Material
AN-BRS-03	SS304
AN-BRS-04	SS316



Model Number	Material
AN-BRS-05	TPU

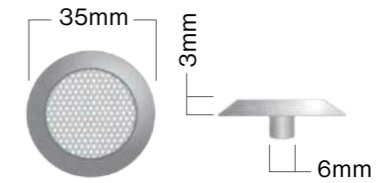

Model Number	Material
AN-BRS-06	SS304
AN-BRS-07	SS316



HealthSeasons tactile tiles are frequently chosen in major barrier-free projects in occasions like railway, airport, disability organization, municipal government etc.

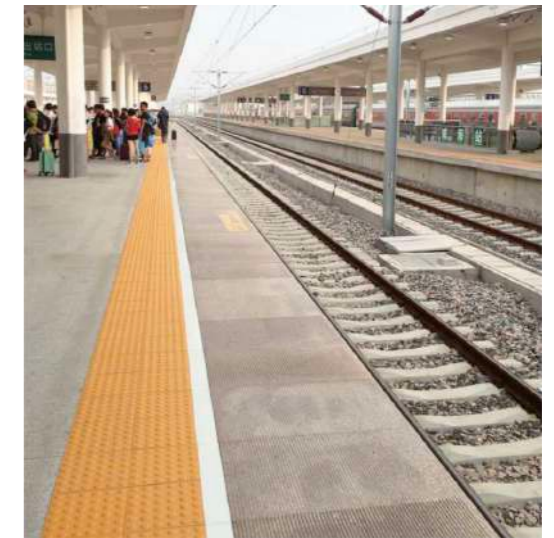
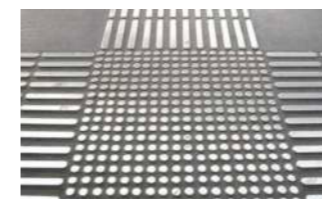



HealthSeasons tactile tiles, widely praised by both domestic and foreign customers, are exported to countries like America, Japan, Australia, Korean etc.





PRODUCT
CATALOGUE

 Line ID : @alunext
 063-4255593 , 095-4165914
www.alunextmaterial.com

Alu Next Material Co., Ltd.